

Pos. Nr. Pos.no.	Beschreibung Description	Art.-Nr. Art.no.	Preisgruppe Price bracket
1	Gehäuse kpl. Betr.Nr. 232 254-3 Body ass. Loco no. 232 254-3	149478	31
2	Kardanschale kurz Cardan reception short	87129	4
3	Motorplatine PL. 22 KM Motor PCB	147735	18
4	Puffer Buffer	106775	4
5	UIC-Steckdose UIC-Socket	114633	3
6	Gummibettung Rubber bedding	89728	4
7	Decoder MX630P Plux 16 Decoder	136162	31
8	Lichtleitstäbesatz Light conductor set	101236	7
9	Motordistanzrahmen KM Motor spacer frame	147694	7
10	Grundrahmen Basic frame	142636	16
11	Tank Tank	149477	10
12	TS-Gehäuse lackiert Part set body painted	134679	12
13	Lokführer Loco driver	110407	6
14	GF-Schraube M2x5 mm Self-tapping screw	114966	3
15	Lichtabdeckungsfolie Light cover foil	115215	5
16	Führerstand lackiert Driver's cab painted	121183	6
17	Motor m. Schwungmasse+Kardansch. KM Motor w. flywheel+cardan reception	147320	24
18	Stirn+Seitenfenster Front+Side windows	149479	8
19	Laufblech Runway	121184	5
20	Motorkontaktfeder lang Motor contact spring long	145560	4
21	Motorkontaktfeder kurz Motor contact spring short	145561	4
22	Scheinwerfer Headlight	140713	4

Änderungen in Konstruktion und Ausführung vorbehalten  
We reserve the right to change the construction and specification

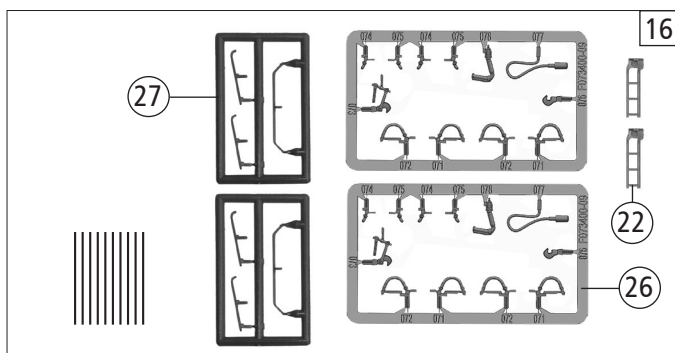
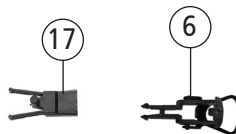
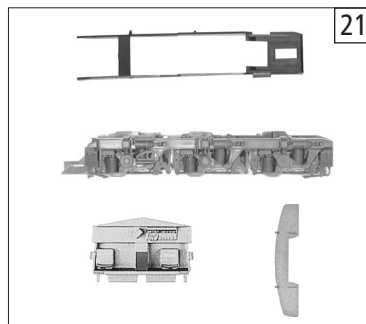
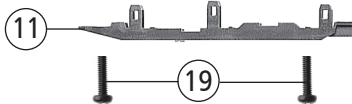
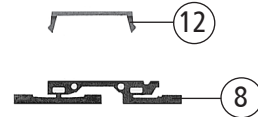
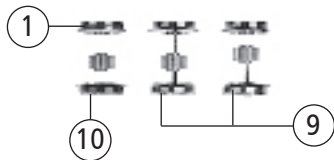
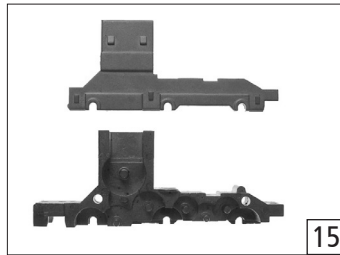
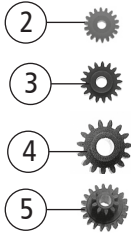
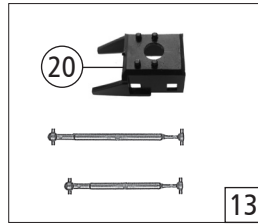
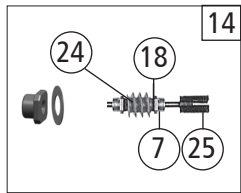

511003		DB-AG	BR 232	=	
Pos. Nr. Pos.no.	Beschreibung Description	Art.-Nr. Art.no.	Preisgruppe Price bracket		
1	Haftringsatz 10Stk. 12,5-13,48mm Set with traction tyres 10 pieces	40066	---		
2	Zahnrad Z=17 M=0,4 G Gearwheel	86418	5		
3	Schnecken Zahnrad Z=16/17 Wormgear	86419	6		
4	Zahnrad Z=18 M=0,4 Gearwheel	86460	3		
5	Zwischenzahnrad Z=14 Intermediate gearwheel	86480	3		
6	Standardkupplung Standard coupling	89246	6		
7	Lager für Schneckenachse Bearing for worm gear axle	89749	6		
8	Radkontakt Wheel contact	89956	5		
9	Radsatz m. Zahnrad o. Haftringen Wheelset w. gear wheel w/o traction tyres	107581	11		
10	Radsatz m. Haftringen m. Zahnrad Wheelset w.gear wheel w.traction tyres	107582	12		
11	Getriebedeckel Gear cover	121182	6		
12	Kontaktalter Contact holder	107586	6		
13	TS - Kardanwelle und Schneckendeckel Part set cardan shaft and worm gear cover	101240	8		
14	Schneckensatz Set of worm gear	147695	13		
15	Getriebeatz Gear set	101244	11		
16	Zurüstbeutel Bag with accessories	142787	11		
17	Kupplungskammer Coupling reception	111944	4		
18	Anlaufscheibe Washer	114622	3		
19	GF-Schraube M1,6x6 mm Self-tapping screw	114836	3		
20	Schneckendeckel Worm gear cover	121285	4		
21	TS - Blende-Getriebeabdeckung Part set bogie-gear cover	112689	13		
22	Leiter Ladder	107589	4		
23	Kurzkupplung-Vorentkupplung Coupling short-Vorentcoupling	115550	6		
24	Schnecke Wormgear	86704	6		
25	Kardanschale Cardan reception	87152	3		
26	TS-Bremsschläuche und Zughaken Part set of brake tubes & coupling hooks	139832	7		
27	TS-Griffe Part set-Handrails	149480	4		